

Microstrip Antenna

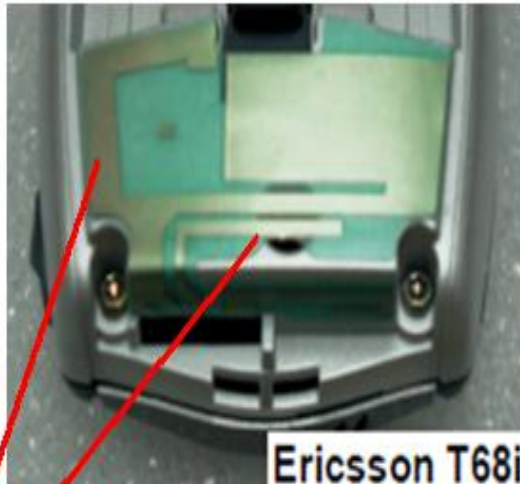

patch 1 for bluetooth 2.4GHz
patch2 two arms for .9 1.8GHz

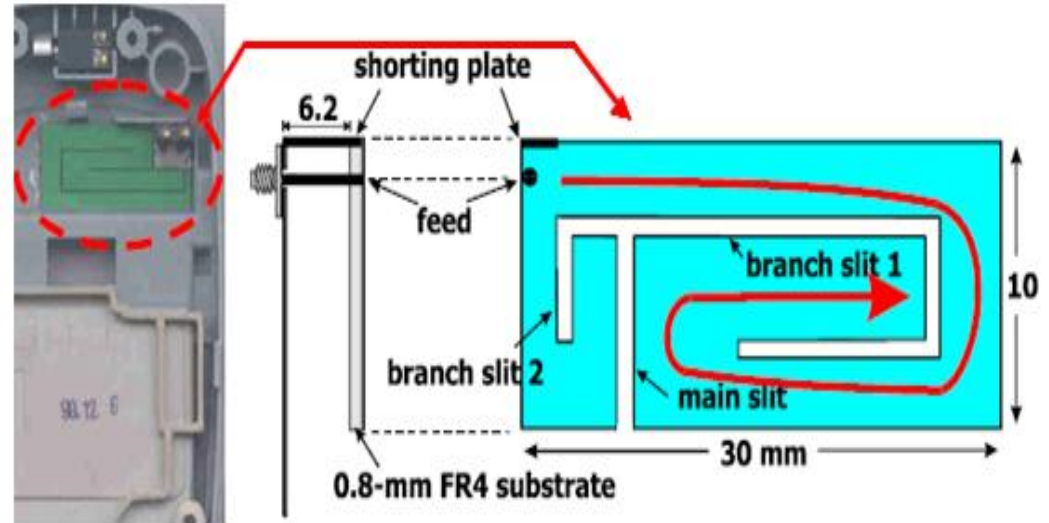

- MSA are applicable in the GHz range ($f > 0.5 \text{ GHz}$). For lower frequencies their dimensions become too large.

Construction and Geometry

Generally the MSA are thin metallic patches of various shapes etched on dielectric substrates of thickness h , ($0.003\lambda_0 \leq h \leq 0.05\lambda_0$). The substrate is usually grounded at the opposite side

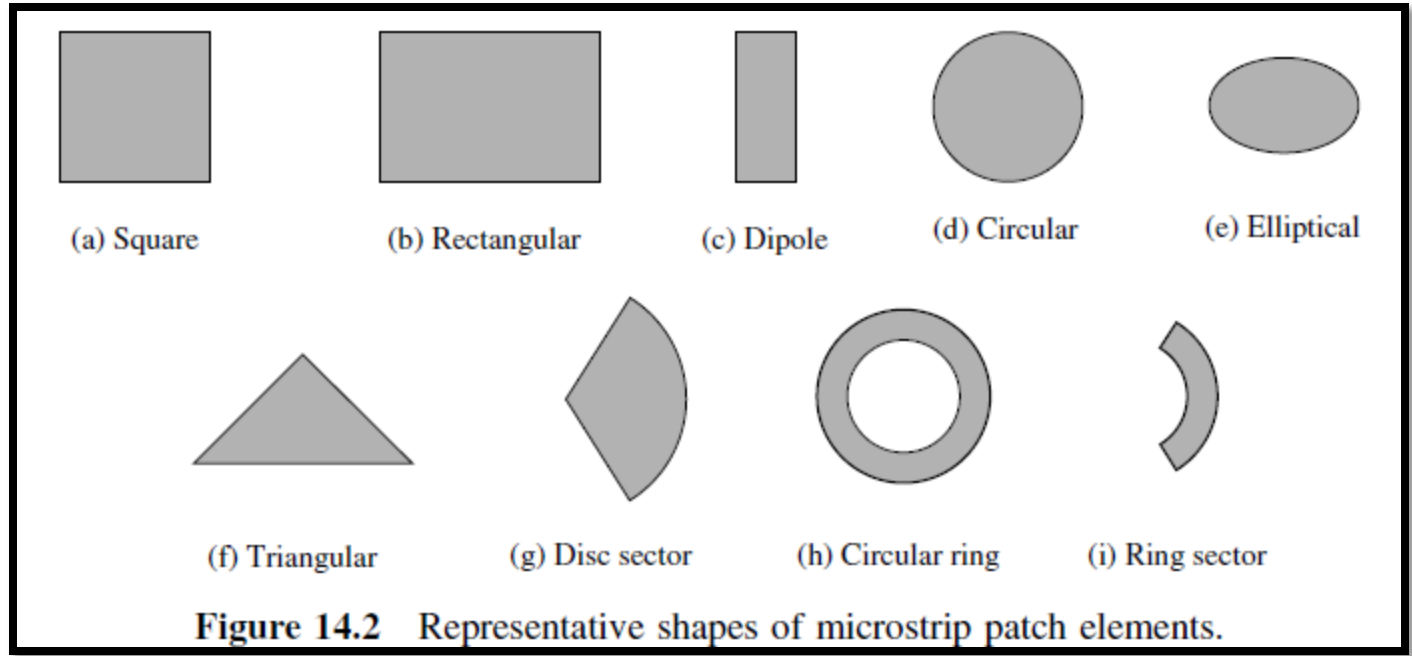
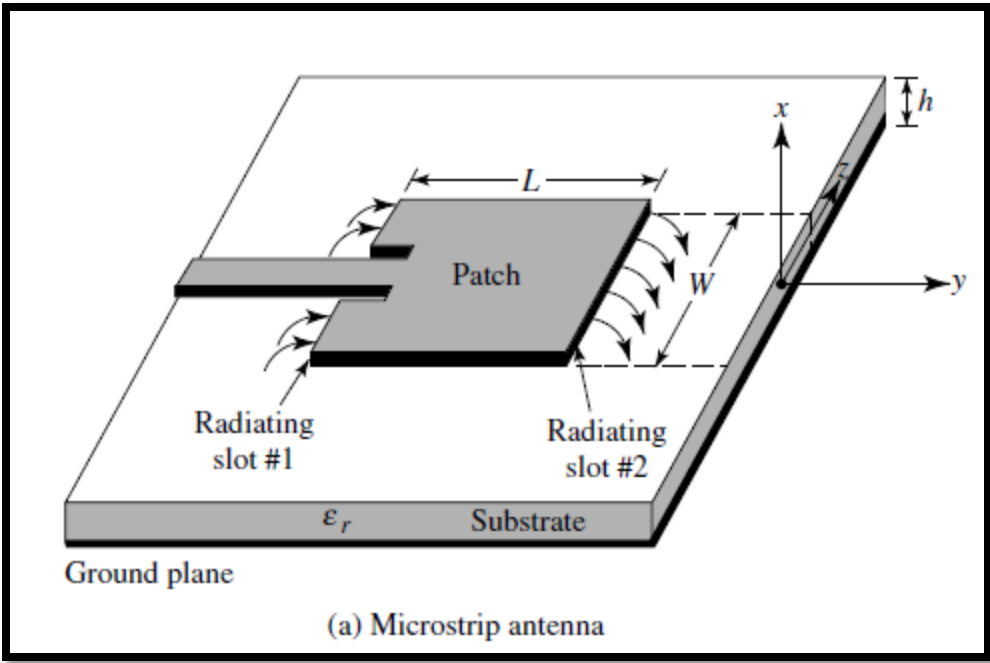

Microstrip Antenna

Advantage of Microstrip Antenna:

1. Low profile.
2. **Simple** and **inexpensive** to manufacture using modern printed-circuit technology.
3. Mechanically **robust** when mounted on rigid surfaces
4. Patch shape are designed for **versatile resonant frequency, polarization, pattern, and impedance**.
5. Adding loads between the patch and the ground plane, (such as pins and varactor diodes), **variable resonant frequency, impedance, polarization, and pattern** can be designed.

Disadvantage of Microstrip Antenna:

1. Low efficiency.
2. Poor polarization purity.
3. Spurious feed radiation.
4. Very narrow frequency bandwidth.

Is there a way to overcome shortage of microstrip antenna:

There are researches to overcome shortage of microstrip antenna as increasing the height of the substrate to extend the efficiency (to as large as 90 percent if surface waves are not included) and bandwidth (up to about 35 percent) .

However, as the height increases, **surface waves are introduced which usually are not desirable because they extract power from the total available for direct radiation**(space waves). The surface waves travel within the substrate and they are scattered at bends and surface discontinuities, such as the truncation of the dielectric and ground plane and **degrade the antenna pattern and polarization characteristics**. Surface waves can be eliminated, while maintaining large bandwidths, by using cavities.*(what is surface wave how can we eliminate)*

- Feeding methods

1. Microstrip feed –

easy to fabricate, simple to match by controlling the inset position and relatively simple to model.

as the substrate thickness increases, surface waves and *spurious feed radiation increase*; this limits bandwidth to 2-5%.

2. Coaxial probe feed –

easy to fabricate, simple to match, low spurious radiation; difficult to model accurately; narrow bandwidth of impedance matching.

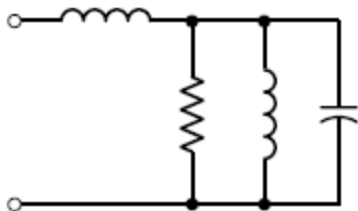

(a) Microstrip line

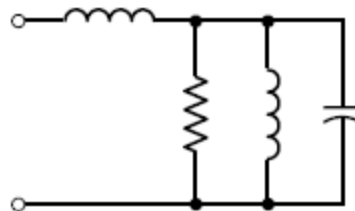

(b) Probe

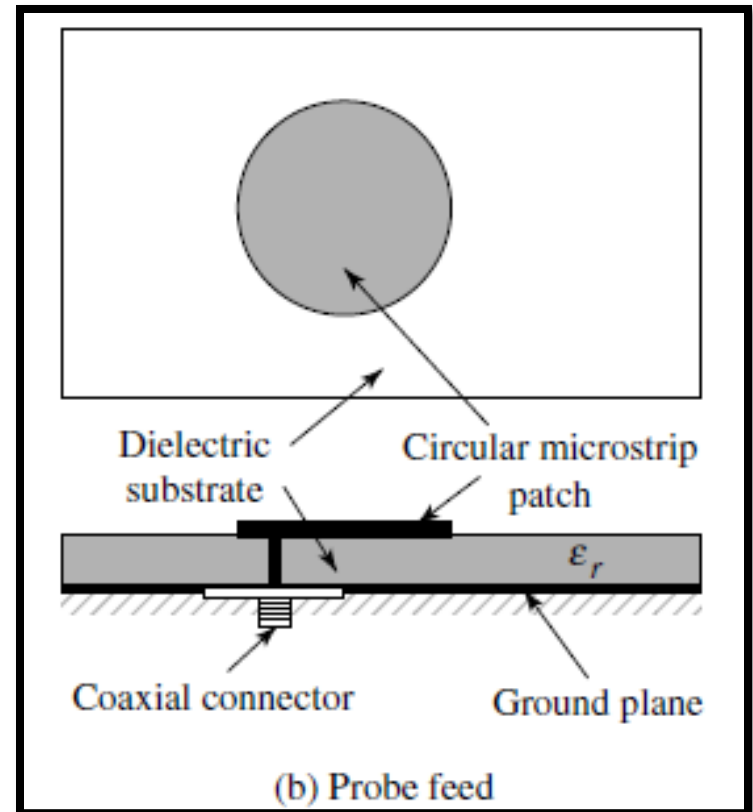

3. Aperture coupling (no contact)

Microstrip feed line and radiating patch are on both sides of the ground plane, the coupling aperture is in the ground plane.

Adv: moderate spurious radiation, easy to model;

- *Independent optimization of feed mechanism and patch (radiating Element)*
- *Ground plane also isolates the feed from patch so minimize Interference of spurious radiation, which considered advantage for pattern formation and polarization purity*

Dis adv: difficult to match, narrow bandwidth.

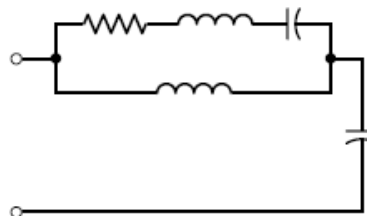
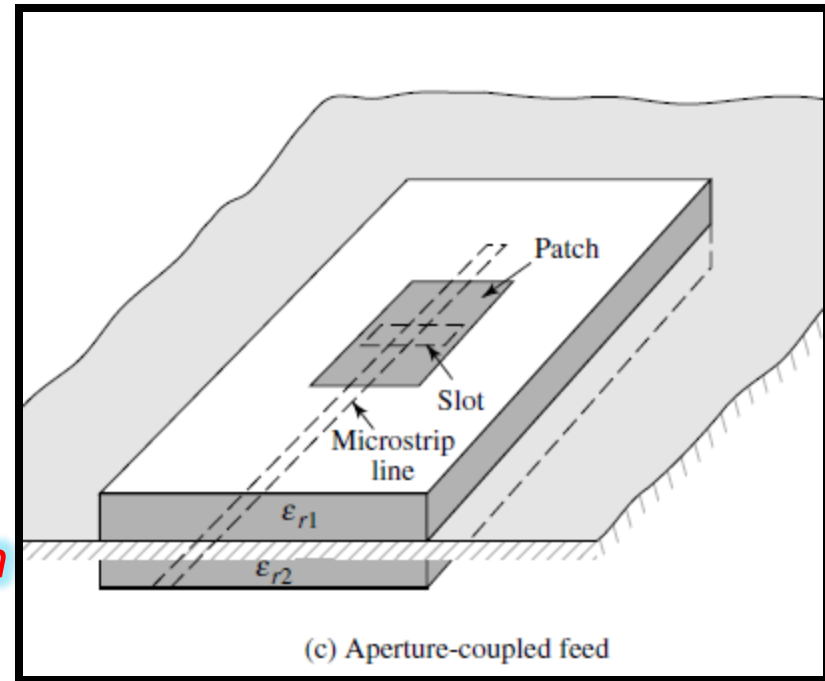

(c) Aperture-coupled

4. Proximity coupling (no contact), microstrip feed line and radiating patch are on the same side of the ground plane –

Adv: largest bandwidth (up to 13%), relatively simple to model, has low spurious radiation.

Dis adv:(fabrication is difficult, cost and size as two dielectric may used

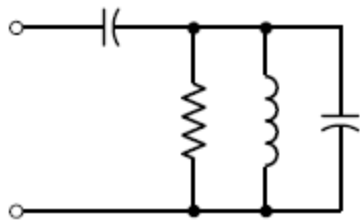

(d) Proximity-coupled

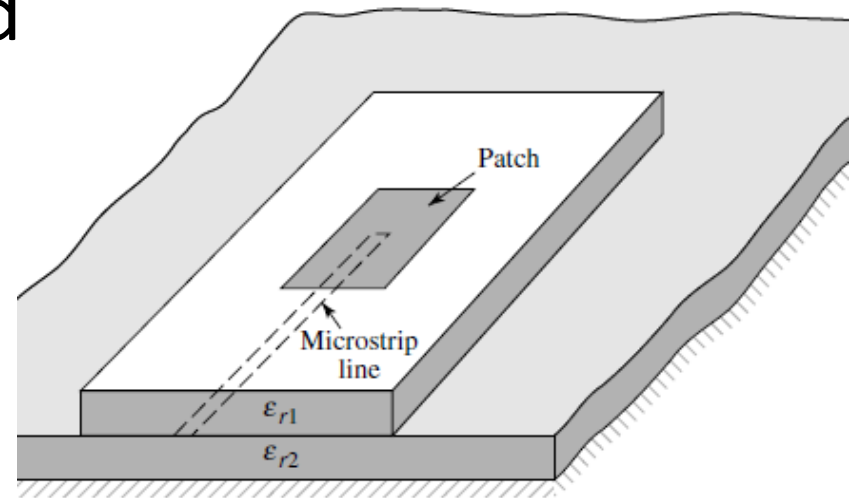

(d) Proximity-coupled feed

Methods of analysis

- Transmission line model
- Cavity model
- Full wave model (most complex but accurate)

Rectangular Patch

Fringing fields are responsible of radiation

- Analyzed using transmission line model and cavity model.

Rectangular Microstrip antenna can be represented as an **array** of two radiating narrow slot each of width W and height h separated by T.L. of a distance L .

This array has a broadside radiation pattern (the peak radiation is in the $+z$ -direction).

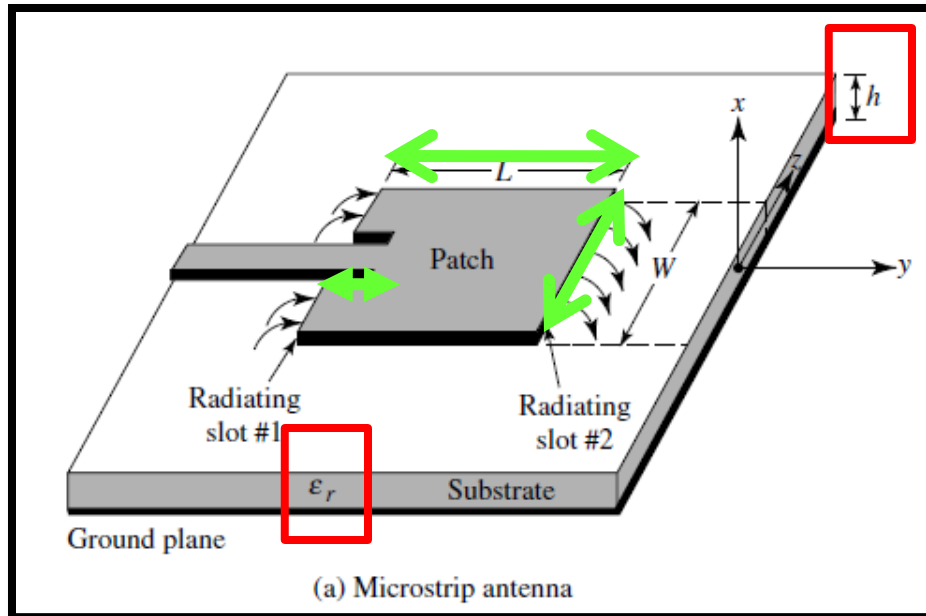

Fringing Effect

Due to finite length of patch electric field at edge undergo fringing.

Fringing effect makes

- the effective electrical length of the patch looks longer than its physical length . $L_{\text{eff}} = L + 2\Delta L$
- Effective dielectric constant $\epsilon_{\text{reff}} < \epsilon_r$ since electric lines travels in air and in substrate(dielectric)

The amount of fringing depend on

- L/h if $L/h \gg 1$ fringing is reduced
- Dielectric material as $\epsilon_r \gg 1$ fringing is reduced.

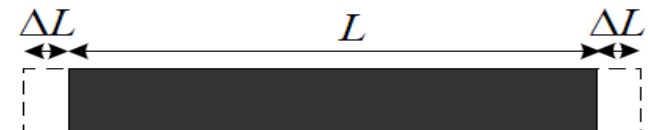
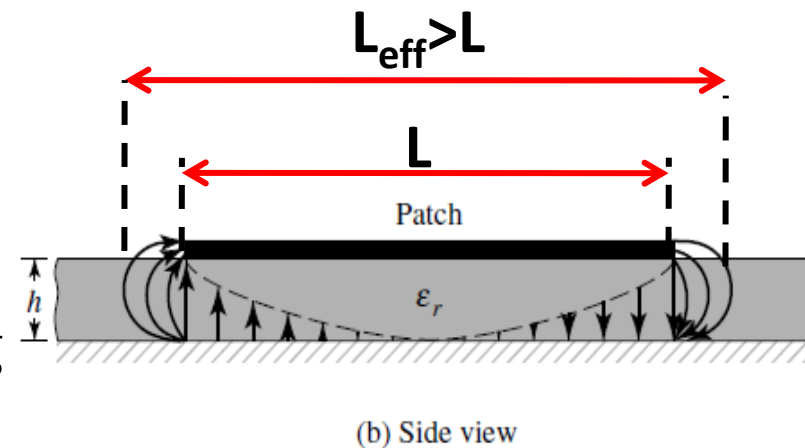
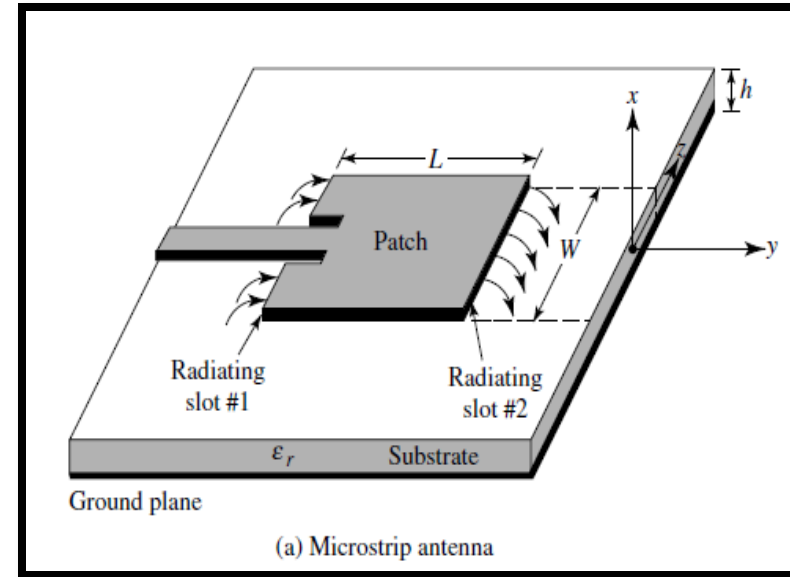

Design Equations:

$$W = \frac{c}{2 f_r} \sqrt{\frac{2}{\epsilon_r + 1}}$$

$$\epsilon_{\text{reff}} = \frac{\epsilon_r + 1}{2} + \frac{\epsilon_r - 1}{2} \left[1 + \frac{12 h}{W} \right]^{-1/2}$$

$$\frac{\Delta L}{h} = 0.412 \frac{(\epsilon_{\text{reff}} + 0.3) \left(\frac{W}{h} + 0.264 \right)}{(\epsilon_{\text{reff}} - 0.258) \left(\frac{W}{h} + 0.8 \right)}$$

$$L = \frac{c}{2 f_r \sqrt{\epsilon_{\text{reff}}}} - 2 \Delta L$$

$$(f_r)_{010} = \frac{c}{2 \sqrt{\epsilon_{\text{reff}}} L_{\text{eff}}}$$

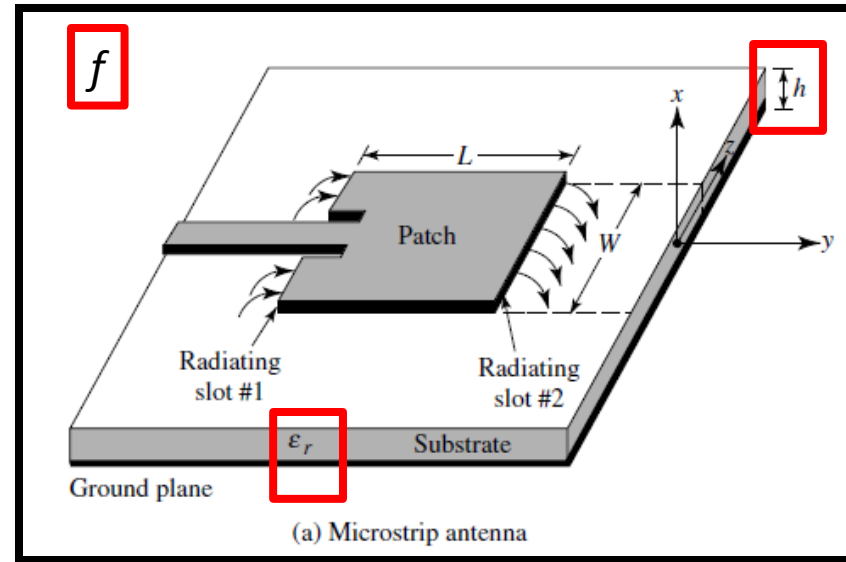

the length of a *half-wave patch* is slightly less than a half wavelength in the dielectric substrate material ($.49\lambda_g$); The amount of length reduction depends on ϵ_r , h , and W . Formulas are available to estimate the resonant length with empirical adjustments.

Example 14.1

Design a rectangular microstrip antenna using a substrate (RT/duroid 5880) with dielectric constant of 2.2, $h = 0.1588$ cm (0.0625 inches) so as to resonate at 10 GHz.

Solution: Using (14-6), the width W of the patch is

$$W = \frac{30}{2(10)} \sqrt{\frac{2}{2.2 + 1}} = 1.186 \text{ cm (0.467 in)}$$

The effective dielectric constant of the patch is found using (14-1), or

$$\epsilon_{\text{reff}} = \frac{2.2 + 1}{2} + \frac{2.2 - 1}{2} \left(1 + 12 \frac{0.1588}{1.186} \right)^{-1/2} = 1.972$$

The extended incremental length of the patch ΔL is, using (14-2)

$$\begin{aligned} \Delta L &= 0.1588(0.412) \frac{(1.972 + 0.3) \left(\frac{1.186}{0.1588} + 0.264 \right)}{(1.972 - 0.258) \left(\frac{1.186}{0.1588} + 0.8 \right)} \\ &= 0.081 \text{ cm (0.032 in)} \end{aligned}$$

The actual length L of the patch is found using (14-3), or

$$L = \frac{\lambda}{2} - 2\Delta L = \frac{30}{2(10)\sqrt{1.972}} - 2(0.081) = 0.906 \text{ cm (0.357 in)}$$

Finally the effective length is

$$L_e = L + 2\Delta L = \frac{\lambda}{2} = 1.068 \text{ cm (0.421 in)}$$

- Inset feed design:

Each radiating slot is represented by a parallel equivalent admittance Y

$$Y_1 = G_1 + jB_1$$

Since slot #2 is identical to slot #1, its equivalent admittance is

$$Y_2 = Y_1, \quad G_2 = G_1, \quad B_2 = B_1$$

At resonance input impedance is purely resistive
Reactance cancelled each other . Hence for TM_{010}

$$R_{in} = \frac{1}{2(G_1 \pm G_{12})}$$

Where:

R_{in} input impedance at edge of patch(i.e at $y=0$)

G_1 conductance of slot 1 , G_{12} mutual conductance between slot1 and slot2.(+) for odd distribution of resonant voltage (as in TM_{010}).

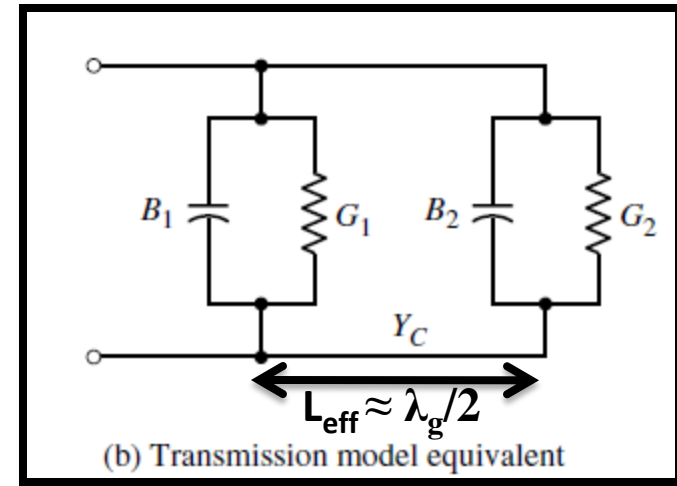

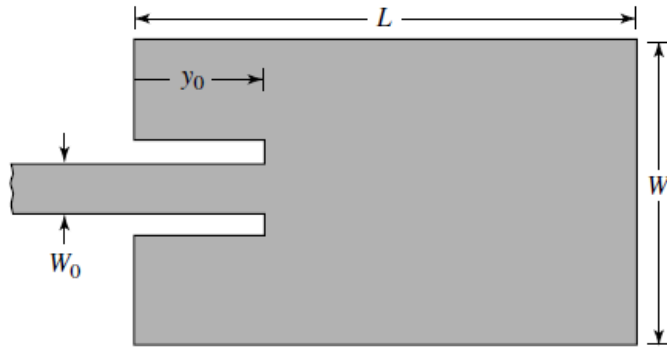

(a) Recessed microstrip-line feed

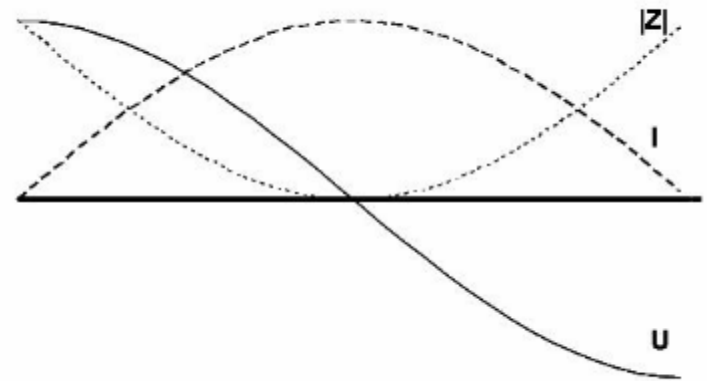

Voltage (U), current (I) and impedance (|Z|) distribution along the patch's resonant length

$$R_{in}(y = y_0) = \frac{1}{2(G_1 \pm G_{12})} \cos^2\left(\frac{\pi}{L}y_0\right)$$

It is desired to have $R_{in}(y=y_0) = 50\Omega$

$$G_1 = \frac{I}{120\pi^2}$$

where

$$I = \int_0^\pi \left[\frac{\sin\left(\frac{k_0 W}{2} \cos \theta\right)}{\cos \theta} \right]^2 \sin^3 \theta d\theta = -2 + \cos X + X \cdot S_i(X) + \frac{\sin X}{X},$$

and $X = k_0 W$, $k_0 = \omega \sqrt{\mu_0 \epsilon_0}$. S_i denotes the sine integral, $S_i(x) = x - \frac{x^3}{3 \cdot 3} + \frac{x^5}{5 \cdot 5} - \frac{x^7}{7 \cdot 7} + \dots = \int_0^x (\sin y) / y dy$.

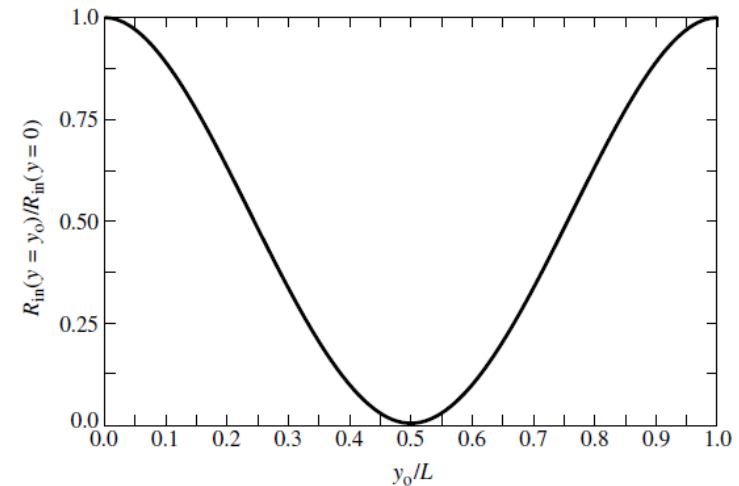

(b) Normalized input resistance

$$R_{in} = \frac{1}{2(G_1 + G_{12})}$$

$$G_1 = \frac{1}{120 \pi^2} \int_0^\pi \left[\frac{\sin\left(\frac{WK_0}{2} \cos \theta\right)}{\cos \theta} \right]^2 \sin^3 \theta d\theta$$

$$G_{12} = \frac{1}{120 \pi^2} \int_0^\pi \left[\frac{\sin\left(\frac{WK_0}{2} \cos \theta\right)}{\cos \theta} \right]^2 J_0(K_0 L \sin \theta) \sin^3 \theta d\theta$$

$$y_0 = \frac{L}{\pi} \cos^{-1} \sqrt{\frac{50}{R_{in}}}$$

Equations cancelled from exam:

- 14-5; 14-8a,14-8b;14-13;14-18;14-19a;14-20 only but 14-20a is included ;

Equations will be given in exam:

14-2; 14-12a; G_{12} value